



TOPSIDE
PRODUCT
GUIDE





TABLE OF CONTENTS



Fast Facts for Retailers	2	Fastening + Rope Drive Installation	6
Topside Kit Contents	3	Installation Details	7
Before You Measure	3	Maintenance	7
Measuring for Installation	4	Warranty	8
Installation Instructions	5	Order Form	9

FAST FACTS

DELIVERY LEAD TIME

Allow 4 weeks from receipt of order at ShadeFX for kit to ship.

PARAMETERS OF DESIGN

MAX LENGTH = **36 feet per canopy**
 MAX WIDTH = **24 feet per canopy**

Standard canopy height from underside of pergola rafters (joists) when retracted = **6"**

Each kit includes:

- 1- Drive Beam**
- 1- Canopy Assembly**
- 1- Instruction and hardware envelope**

- Tracks over 24' long use cable drive that adds 10" to overall track length for same canopy length.
- This system is not designed for a snow load. Needs to be removed or covered in winter.
- Motor mounts perpendicular to drive beam. Fabric is 4" narrower than the wings for clearance with the captive stabilizers.

THE DIFFERENCE BETWEEN WATERPROOF AND WATER RESISTANT

If the canopy will be relied on to keep things dry underneath for the time of a rain shower, water resistant is suitable. If the canopy is expected to keep things dry underneath during the course of a week or for a whole season, then Sattler waterproof fabric is required. **Waterproof fabrics are not available in patterns, only solid colours.**

PRODUCT CAPABILITIES

ShadeFX™ was designed to be flexible and adaptable to most if not all structures in need of a shade canopy. Therefore it can be installed in the following ways:

- Horizontally parallel to rafters
- Horizontally perpendicular to rafters
- On a slope to shed rain parallel to canopy wings from 1° to 45°
- On a slope to shed rain perpendicular to canopy wings from 1° to 45°

- With a bow in the wings so they fit the arch of a curved pergola frame (like a barrel vault)
- With more than 1 drive so the canopies operate independently

WHY SHADEFX™, WHY NOW?

Over the years, homeowners and businesses have moved their attention to an outdoor living lifestyle, where outdoor patios and decks have grown in size and sophistication. Decks now commonly run the full length of the house and have multiple levels, including built-in hot-tubs, outdoor fireplaces and are accessorized with expensive furniture and even complete outdoor kitchens. The outdoor deck has become a key entertainment centre for many families, while the health threat of cancer from UV exposure has increased. This has created a demand for shade products to go with the decks as evidenced by the continued growth of the shade canopy market.

TOPSIDE KIT CONTENTS

- 1** Motor Assembly Qty 1
(with motor drive only)

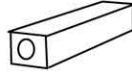

- 2** Drive Beam Qty 1
Integral one piece assembly
May come in 2 pcs which splice together.
Comes with slotted foot mounts (4 shown)

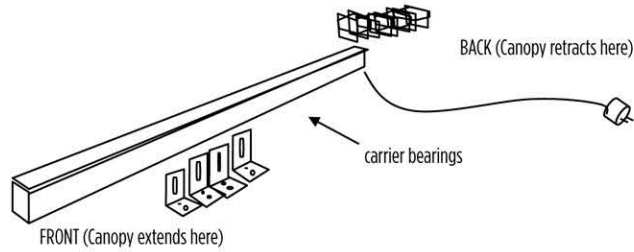

- 3** Canopy Assembly Qty 1

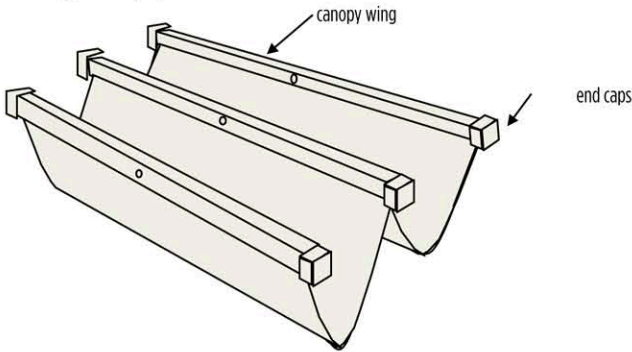

- 4** Angle stabilizers Qty 2
May come in more than one pce per stabilizer depending on length. Slotted foot mounts Qty 2 per 6 ft of stabilizer

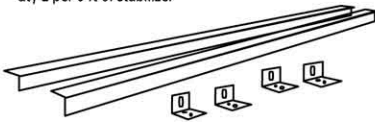

5

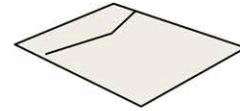

Instructions and hardware including all mounting screws and tether cable assemblies

6

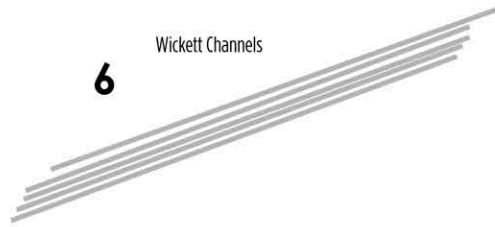

7



BEFORE YOUR MEASURE: RAIN MANAGEMENT

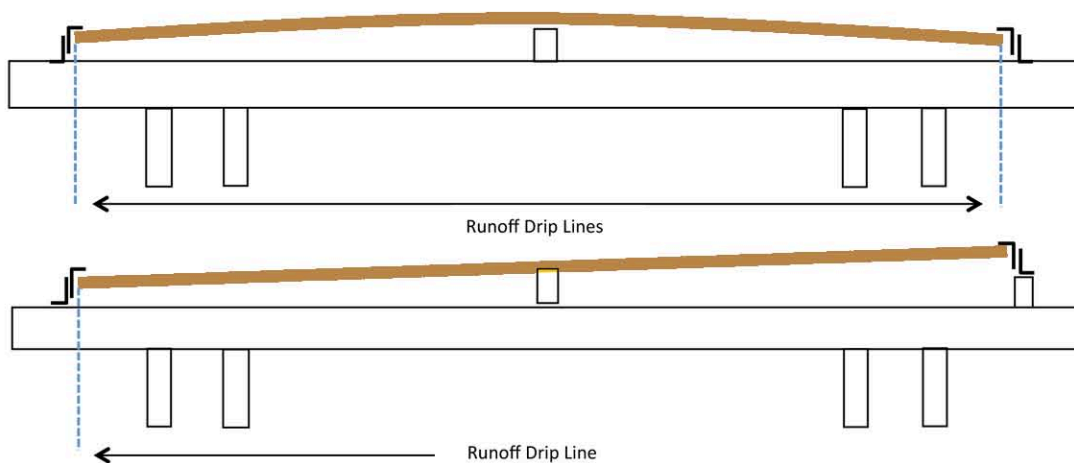

MEASURING FOR INSTALLATION

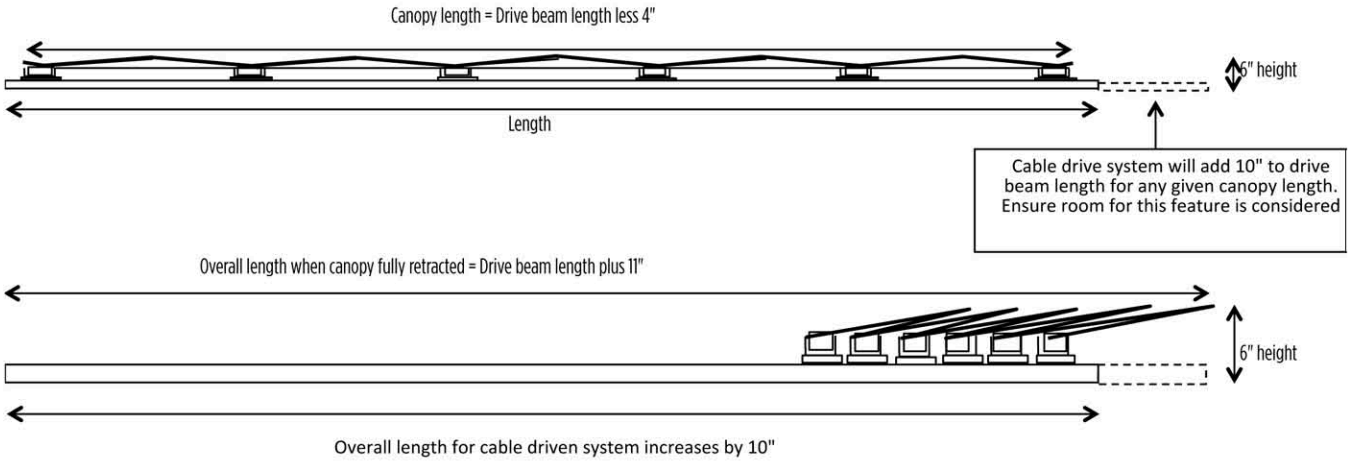

Area to Cover

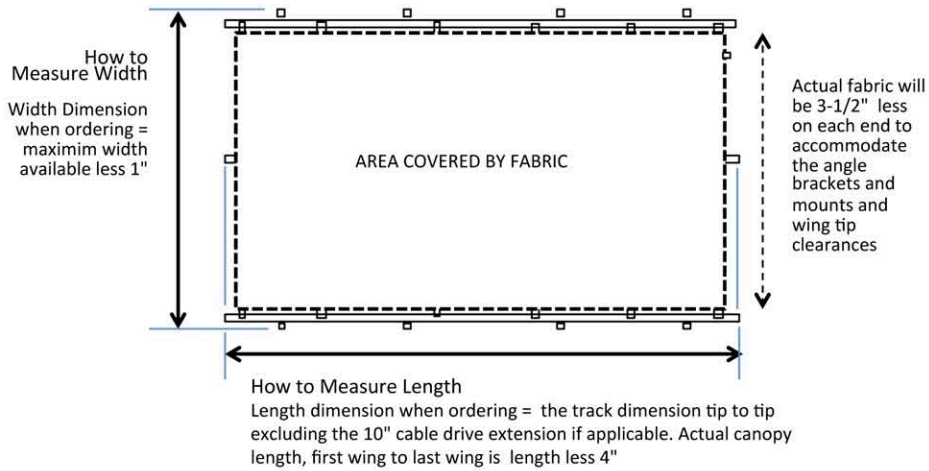

Retracting against a structure

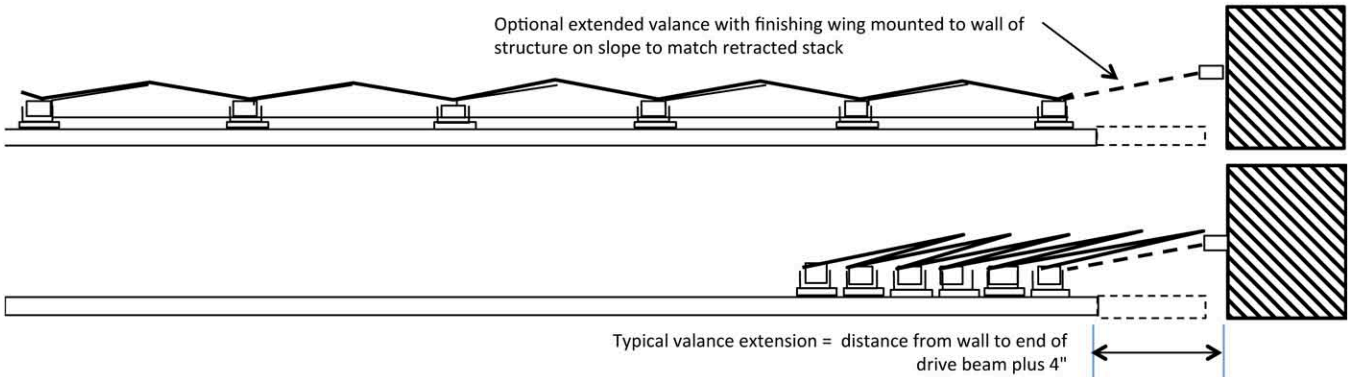

Mounting Brackets

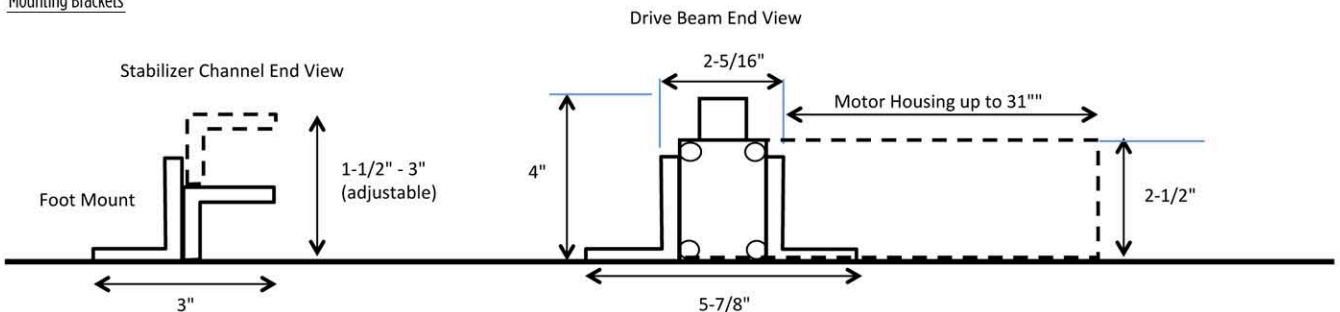

INSTALLATION

1 - Mount drive beam to top of pergola. Ensure it does not span more than 60" unsupported or 48" if it is over 16' wide. Attach motor if motor drive.

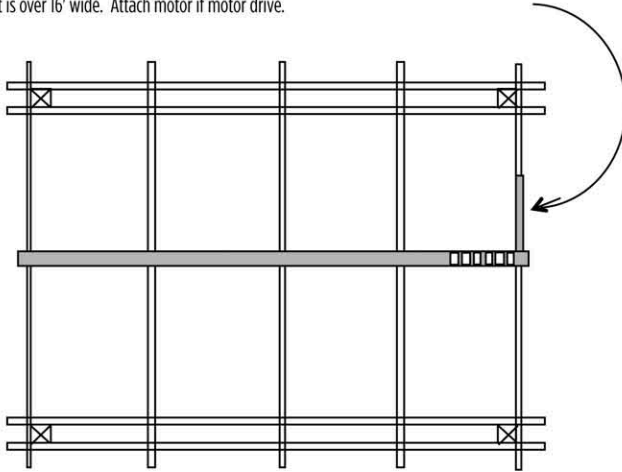

train cable in red



2 - Attach canopy wing assembly to carrier bearings. Starting at the front and proceeding to the back (Fabric shown in cutaway) Holes in wings face backward.

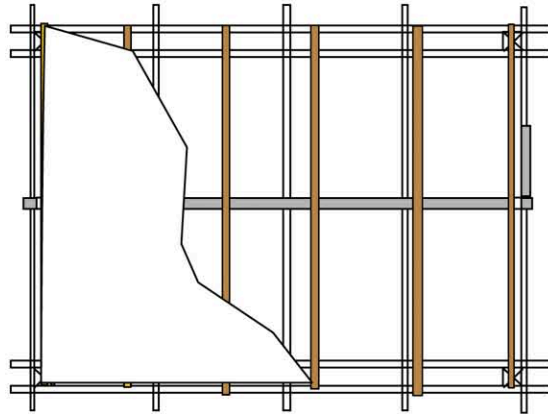

wings in yellow

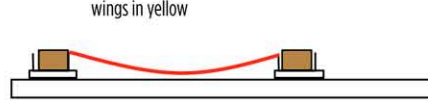

3 - Install wicket brackets by press fitting into holes drilled on back face of canopy wings.

Fabric Not Shown For Clarity

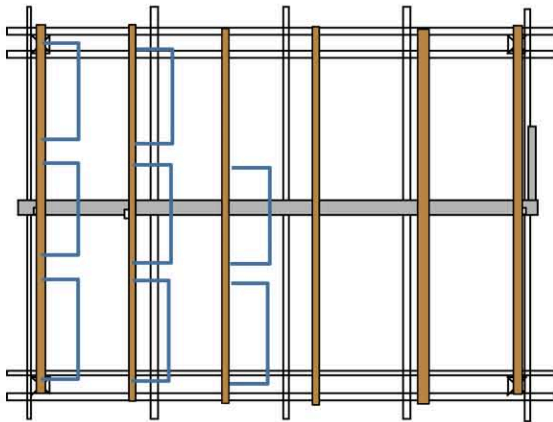

wicket brackets in blue

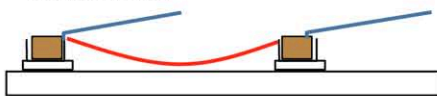

4 - Install wicket channel stiffener on to wicket rods such that the individual wickets act as one across the full width of the canopy

Fabric Not Shown For Clarity

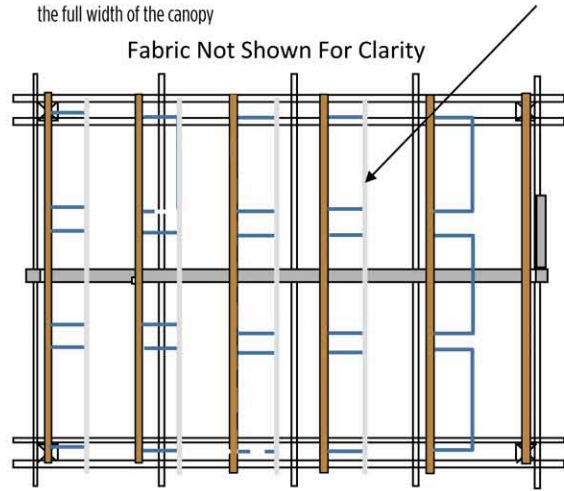

wicket channels in grey

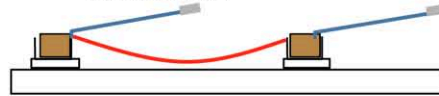

INSTALLATION

5 - Attach lanyard cable to wicket channel to ensure spacing cable is pulled into the canopy folds during retraction.

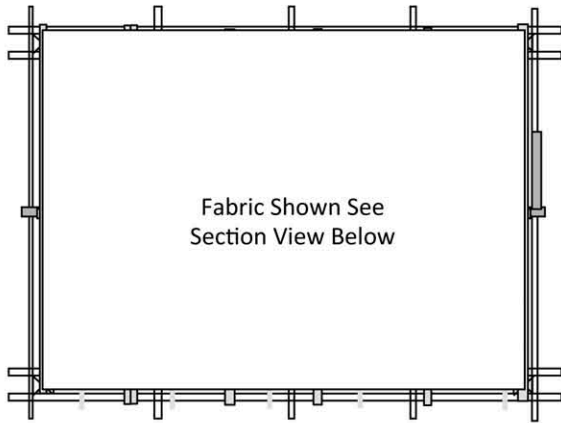

Fabric Shown See Section View Below

lanyard cable in green



6 - Install stabilizers. Picture below depicts installation in section view from the front (extended end)

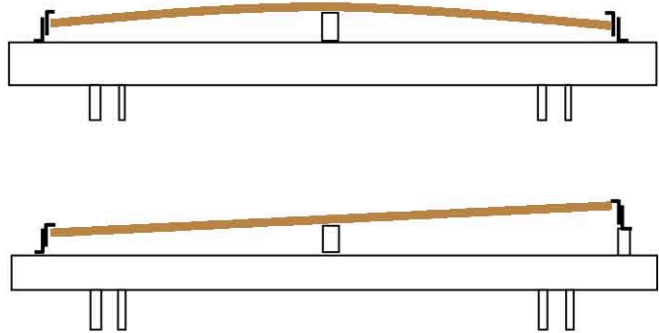

NOTE: Tension set in the wings should not require more than 3 lb force to move the wing off contact with the stabilizer. Excessive tension will place undue strain on the drive system.

FASTENING DIAGRAM

GOOD

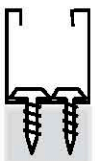

A pair of anchor screws equally torqued into the drive beam side by side will maintain channel shape.

BAD

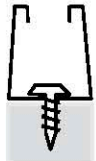

One anchor screw torqued in the middle of the drive beam will pinch the channel and cause a jam point in the track.

CAUTION - At the retracted end of the drive beam, ensure the mounting screws are used at every opportunity to fasten to a joist or beam because the entire weight of a wet canopy is concentrated at that end when not in use

ROPE DRIVE INSTALLATION

- Locate and anchor the rope pulleys as shown below or any appropriate variation for your specific pergola.
- Pull excess rope through the front wing mount
- With tension spring double it's normal length, tighten cinch bolt to secure the rope. You cannot overtighten this bolt.
- Cut off excess rope close to the wing bracket and use a flame to melt the frayed ends of the rope.

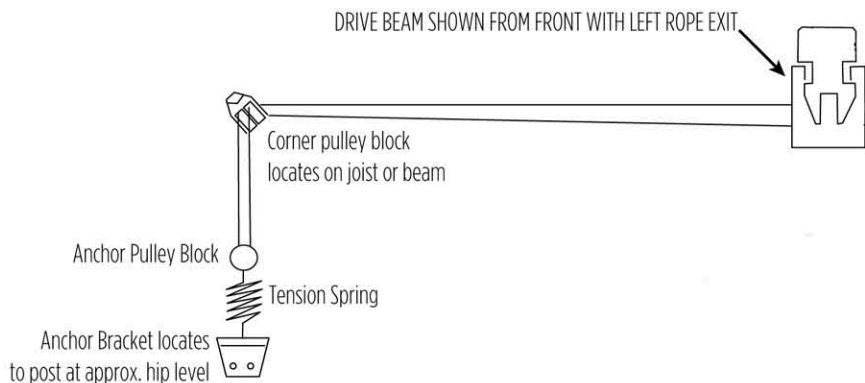

INSTALLED DETAILS

Cross section from side showing completed drive beam, bracket assembly with train cable and lanyards installed

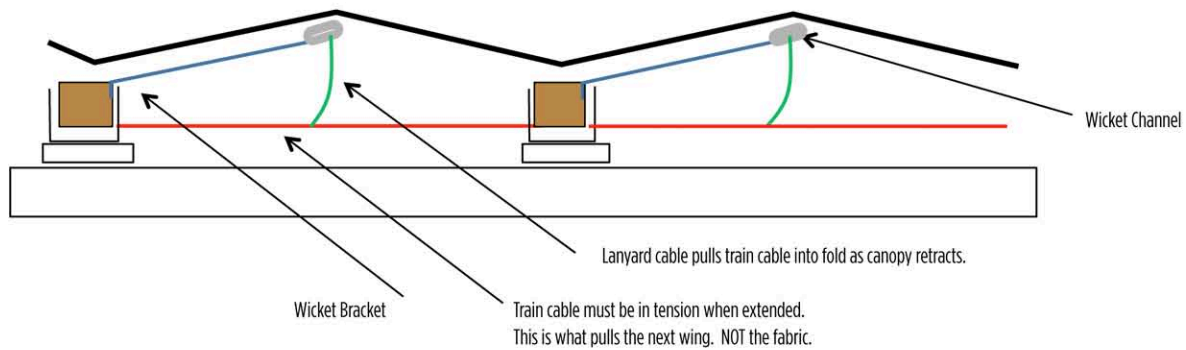

EXTENDED

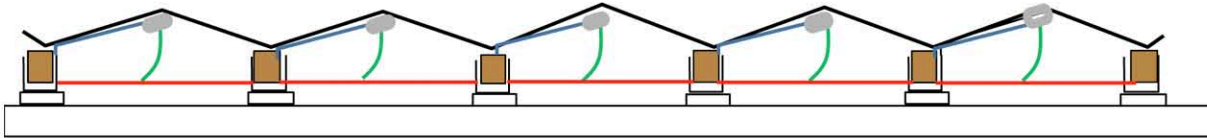

RETRACTED (hardware and cables not shown)



Thank You for choosing a ShadeFX™ Topside Canopy System

MAINTENANCE

ShadeFX is designed to be a maintenance free system. There is no need to lubricate, clean or adjust anything in the mechanism or motor system.

Annual inspection of the track should be performed to ensure it is free of foreign materials or debris.

Fabric maintenance is limited to reasonable cleaning of the fabric when it becomes soiled or stained. The fabrics are made for heavy duty outdoor use.

In all cases a powerful hose-off (not pressure wash) with a mild brush scrubbing (no soap) is all that is needed to remove more stubborn stains/dirt.

Tree gum, sap and grease are best removed with acetone or turpentine.



ShadeFX® products are warranted to be free of defects in material and workmanship for twelve years from the date of installation of the canopy system. During the first 5 years, parts, labour, and shipping (if applicable) are covered. During this period it is the responsibility of the purchaser to notify ShadeFX Canopies Inc. or its representative/dealer, of any claimed defect. Upon investigation, and subsequent confirmation of a legitimate defect, ShadeFX Canopies Inc. will at its option and expense either repair the canopy or provide a replacement. After the first five years of warranty expires, the warranty is limited to replacement of parts associated with the mechanical components of the system and is prorated for the remaining seven years of warranty and does not include shipping and labour costs associated with warranty support. The canopy and the motor (if applicable) are covered by their respective manufacturer's warranties.

The foregoing does not cover and ShadeFX Canopies Inc. (SFX) makes no warranty with respect to:

1. Failures not reported to SFX within (30) days of delivery/installation.
2. Failures or damage due to negligence, other than that of SFX, accident, abuse, improper installation, improper operation or abnormal conditions including abrasion with adjacent objects, or discoloration, staining, or physical damage from extended exposure to heavy wind that would cause violent flapping of fabric, or physical damage from natural flora or fauna.
3. Shade canopies that have been in any way tampered with, repaired or altered by anyone other than an authorized representative of SFX.
4. Shade canopies damaged in shipment or otherwise without the fault of ShadeFX Canopies Inc.
5. Expenses incurred by the Purchaser in an attempt to correct or repair any alleged defect.
6. Any losses, costs, expenses, liabilities and damages (including but without limitation to loss

of use or profits, damage to persons or property, all liabilities of the purchaser to its customers or third persons, and all other special or consequential damages), whether direct or indirect, and whether or not resulting from or contributed to by the default or negligence of ShadeFX Canopies Inc., its agents, employees or subcontractors, which might be claimed as the result of the use or failure of the product shipped.

Purchaser shall not return canopies or parts thereof alleged to be defective without the approval of SFX. All parts claimed defective shall be substantially manifested by the purchaser to the satisfaction of SFX prior to any product being returned to the factory. The SFX factory will not accept collect shipments without prior written approval and authorizing claim code. SFX makes no further warranty, either express or implied or by trade usage in connection with the design, sale or use of its products. The liability of ShadeFX Canopies Inc. on its warranty shall in no event exceed the cost of correcting the defects in the product sold or replacing the same with non-defective product.

This warranty stated herein is in lieu of all other warranties expressed or implied, or merchant ability, or fitness for particular use and under no circumstances will Seller be liable for incidental or consequential damages.

COMPONENT MANUFACTURER WARRANTIES

If your Warranty issue involves the canopy fabric or the motor drive, ShadeFX will facilitate support and continue to be your one point of contact to resolve any claims within the coverage of the following manufacturer's warranties:



SUNBRELLA FABRIC CANOPY

WARRANTY - This limited warranty is valid only if a copy of the invoice for the item purchased is submitted showing date of original purchase.

WHAT IS COVERED? - This limited warranty covers the fabric becoming unserviceable because of loss of color or strength from normal usage and exposure conditions, including sunlight, mildew and atmospheric chemicals. Consumer is responsible for normal care and cleaning of the fabric. This warranty covers fabric only. Glen Raven's liability is expressly limited to this warranty.

HOW LONG IS THE COVERAGE PERIOD? - For Sunbrella®, Sunbrella Plus® and Sunbrella Firesist® this limited warranty coverage runs for five years from the date of original installation.

WHAT WILL GLEN RAVEN DO? - Glen Raven will supply new fabric free to replace the fabric that becomes unserviceable.

HOW CAN YOU GET SERVICE? - Call the dealer or retailer from whom you purchased the product, to inspect the claim. They, in turn, will contact the manufacturer of the item purchased. The manufacturer will then contact Glen Raven and secure replacement fabric for you.

SOMFY DRIVE MOTOR

Somfy offers end product suppliers a 5 year warranty on all motors and controls. Specifically, Somfy warrants its motors and controls to be free from defects in material and workmanship under normal and proper use for a period of 5 years commencing with the date stamped on each product. If the Somfy product fails within this 5 year period, we will repair or replace it free of charge through your end product supplier.

**PRODUCT WARRANTY AND CONTACT INFO:
CALL TOLL FREE: 855-509-5509 FOR IMMEDIATE SUPPORT**

SHADEFX TOPSIDE ORDER FORM

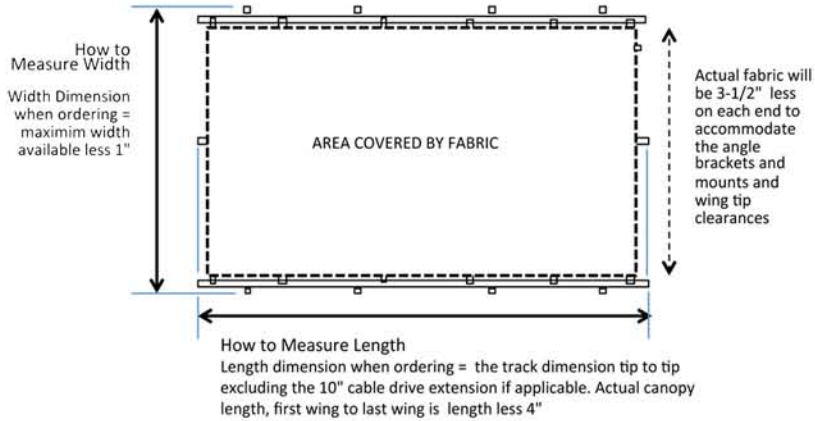

Bill To:

Ship To:

Length of drive beam (overall length tip to tip)

Width of canopy wings (overall length tip to tip)

Width of fabric on wings

Drive Type Rope Pulley: Left Right Down Motor

Drive Beam Parallel to Rafter Perpendicular to Rafter

Drive Beam & Wing Finish Aluminum White Custom Color

Fabric Selection Name and #

Rear Valance - Extension to Wall or Structure Yes No

Cable Drive (for Drive Beams over 24 feet) Yes No

Net Purchase Price (excluding taxes and freight)

Total Amount

Authorized By/PO #:

Date:
